

KIT 650B

KIT 750B, 860B, 960B

KIT 1060B

	MAX A	MAX B	V1	V2	K	F
KIT 650B	6440 mm	3614-3734 mm	3774 mm	4200 mm	6580 + 3000 mm	48
KIT 750B	7440 mm	3826-3946 mm	3986 mm	4550 mm	7580 + 3000 mm	48
KIT 860B	8540 mm	4076-4196 mm	4236 mm	4800 mm	8680 + 3000 mm	48
KIT 960B	9540 mm	4076-4196 mm	4236 mm	4800 mm	9680 + 3000 mm	48
KIT 1060B	10540 mm	4311-4431 mm	4471 mm	5175 mm	10680 + 3000 mm	48

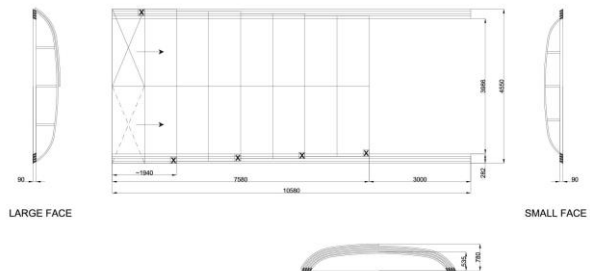
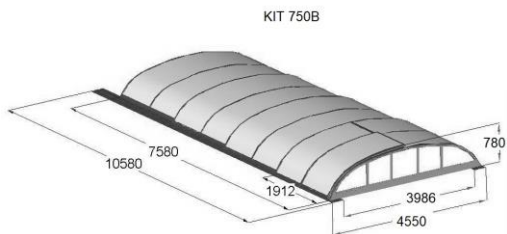
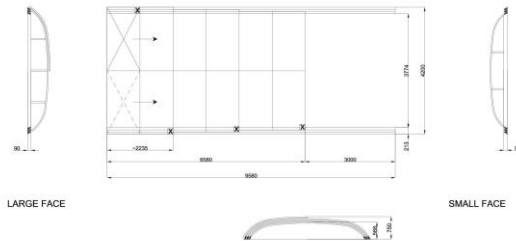
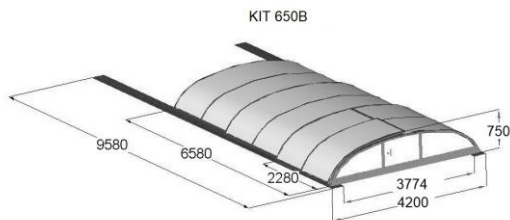
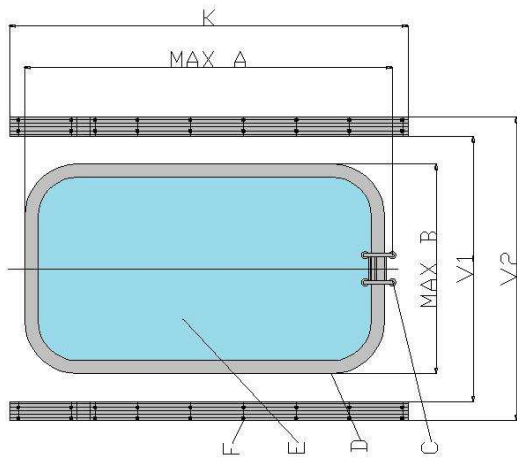

KIT 860B

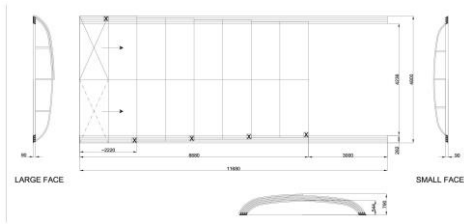
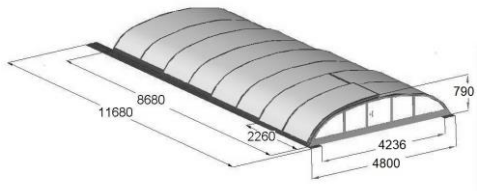

KIT 960B

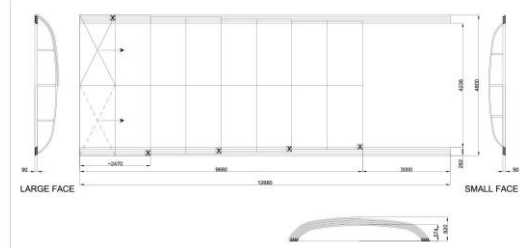
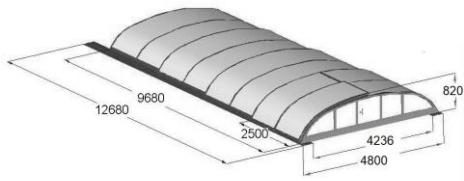

KIT 1060B

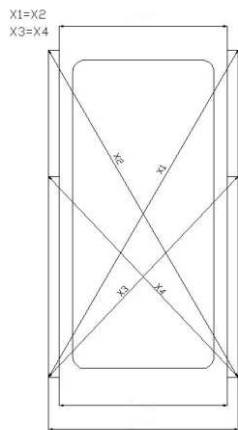
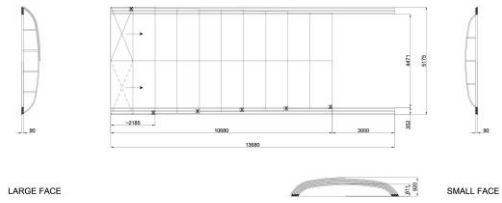
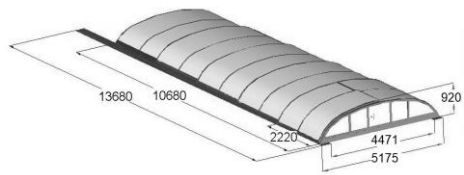

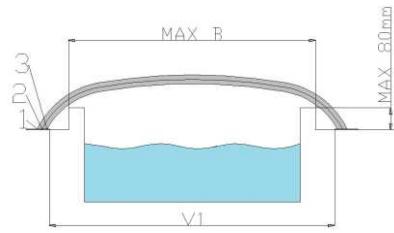
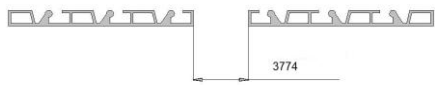

V1= 3774 mm

MAX B= 3614-3734 mm

KIT 650B

X1=X2

X3=X4

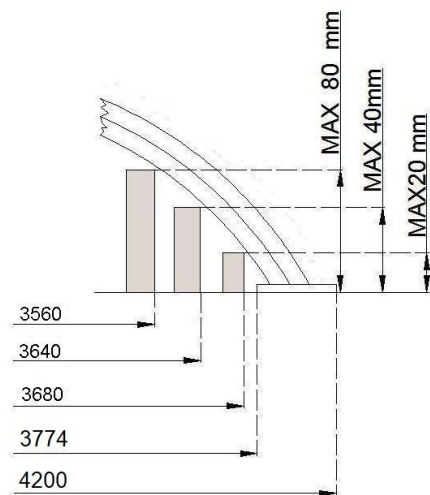
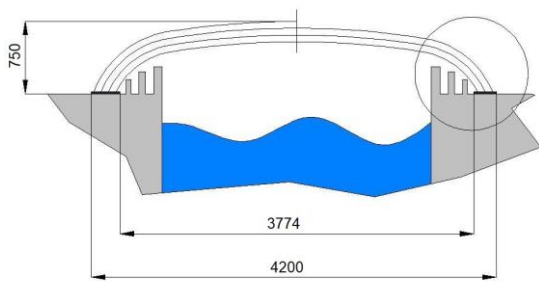
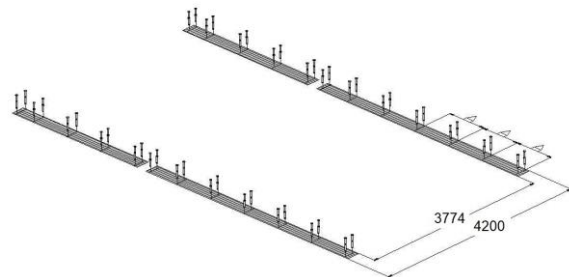
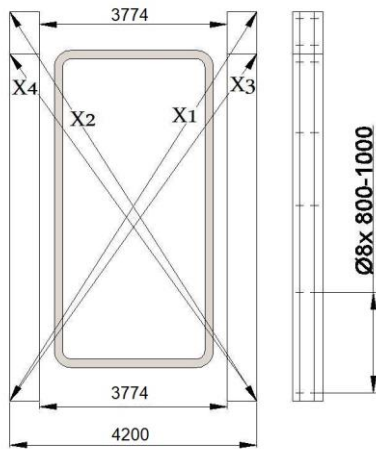

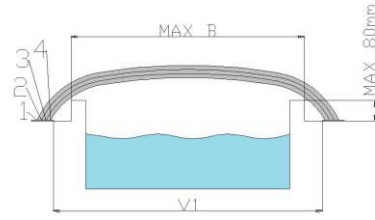
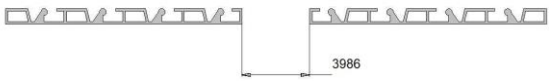

KIT 750B

X1=X2  
X3=X4

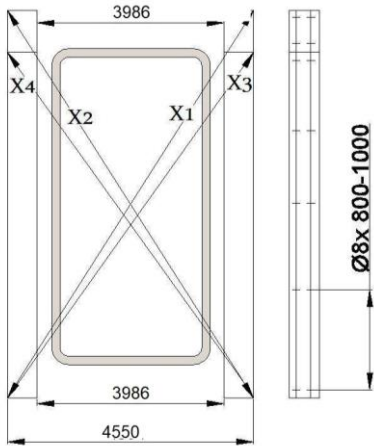

V1= 3986 mm

MAX B= 3826-3946 mm

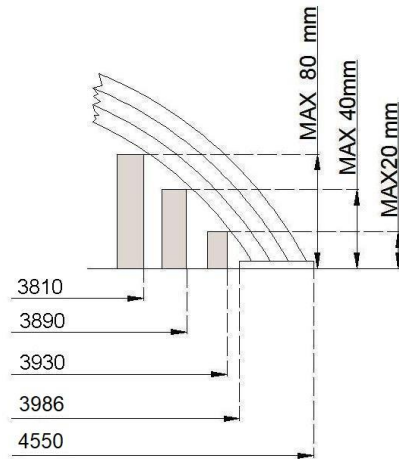
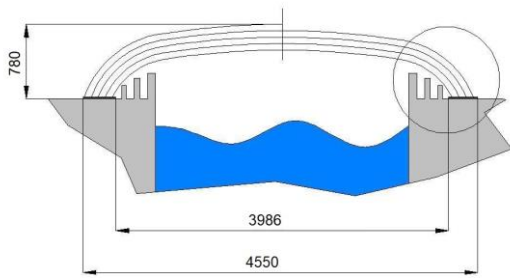
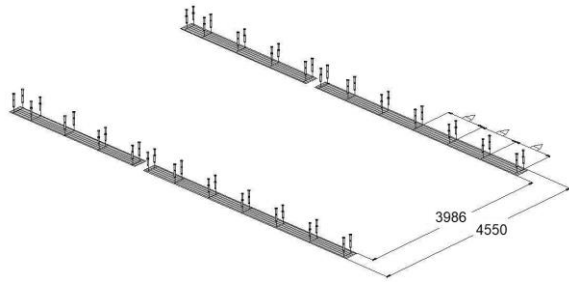

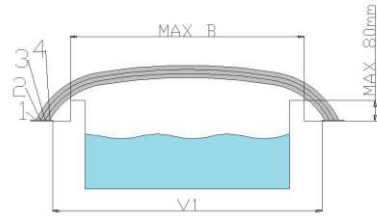
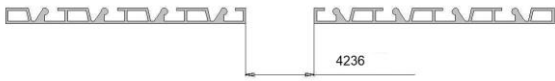

KIT 860B

V1= 4236 mm

MAX B= 4076-4196 mm

X1=X2  
X3=X4

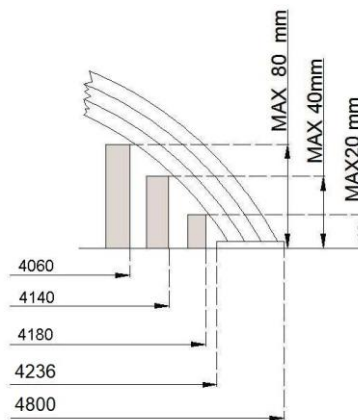
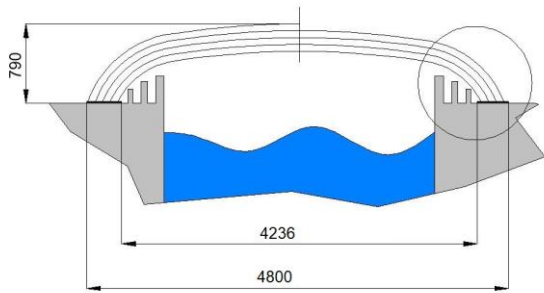
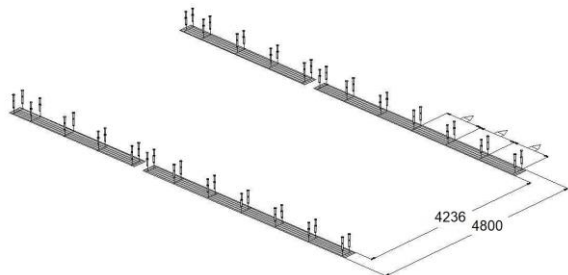
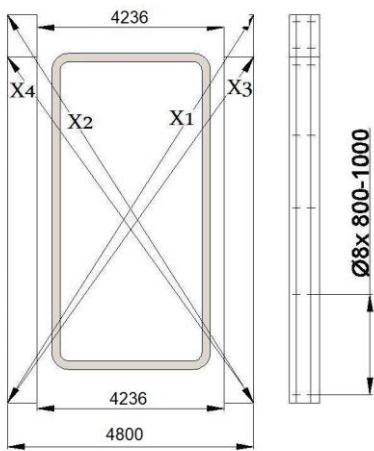

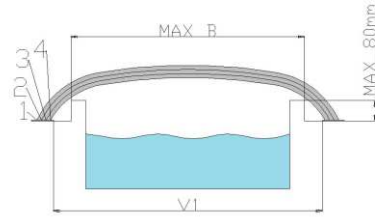
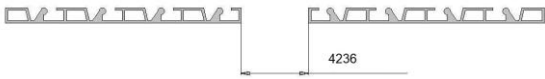

KIT 960B

V1= 4236 mm

MAX B= 4076-4196 mm

X1=X2

X3=X4

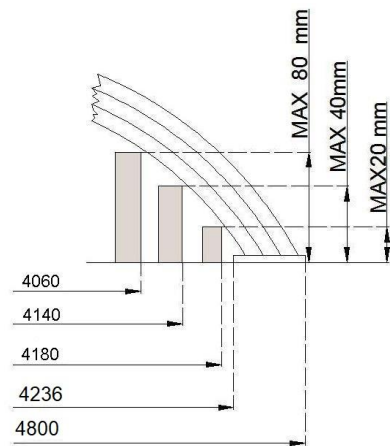
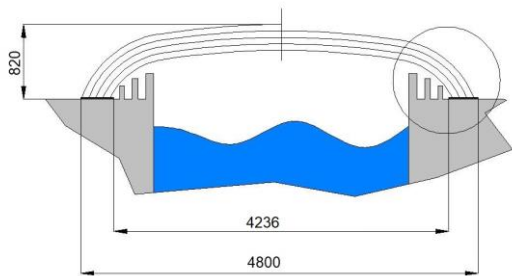
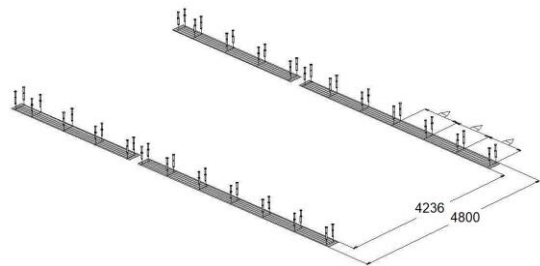
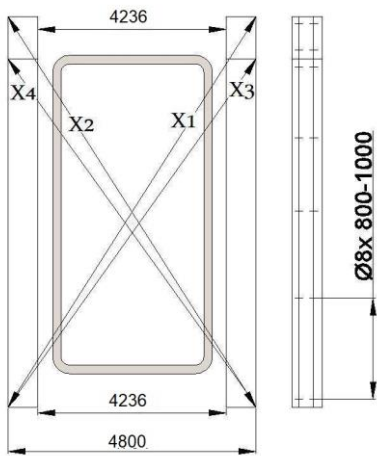

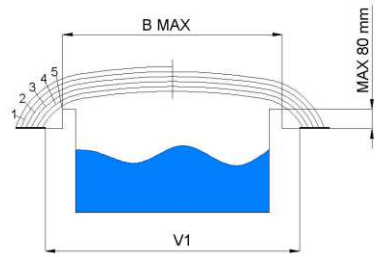
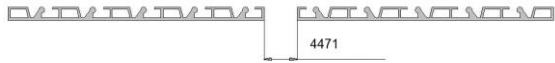

KIT 1060B

V1= 4471 mm

MAX B= 4311-4431 mm

X1=X2



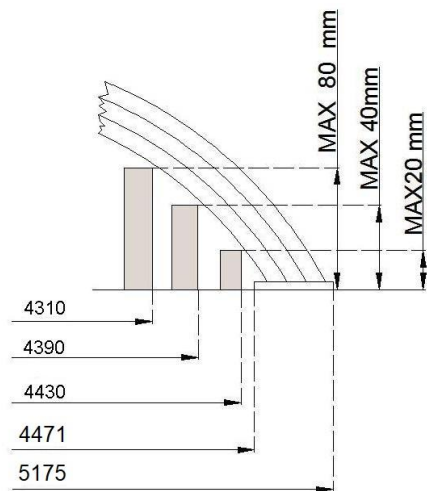
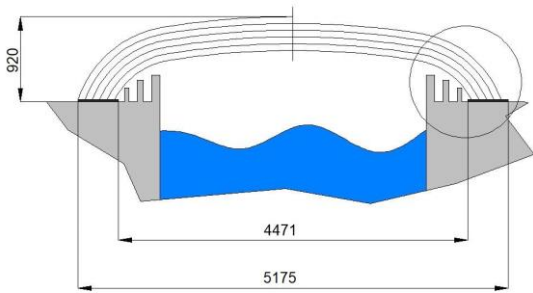
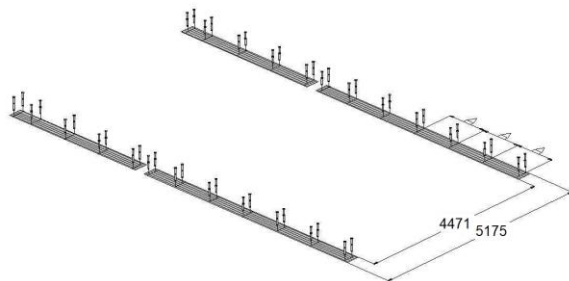
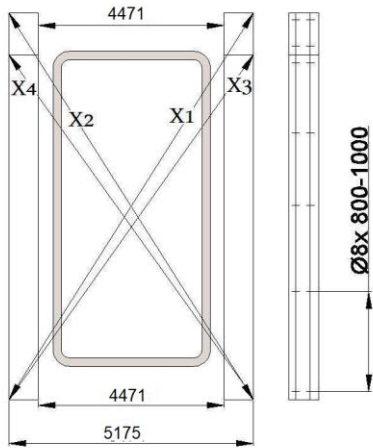



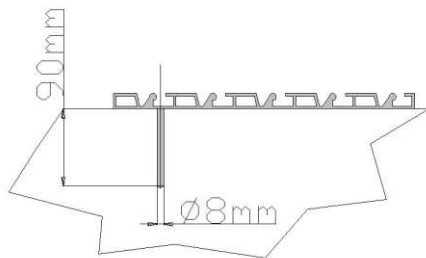
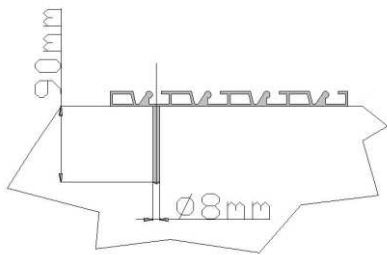
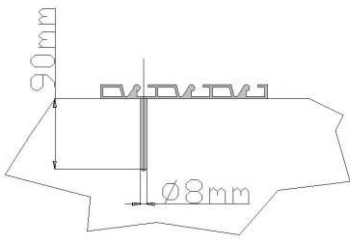
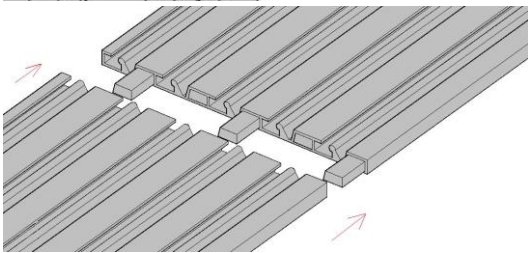
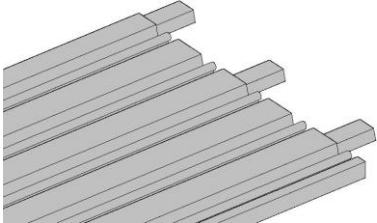
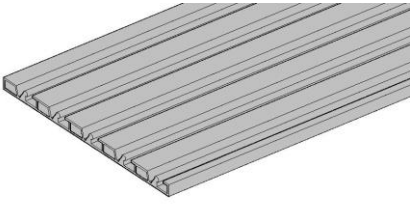

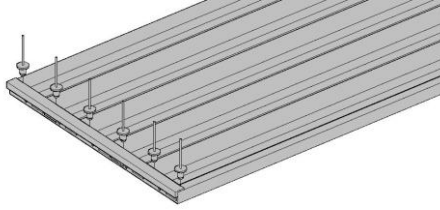
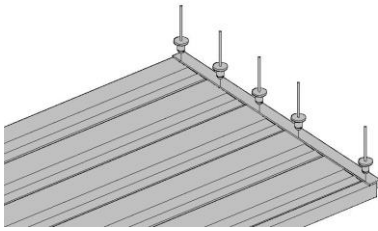

X3=X4









											
KIT 650B	36	12	136	44	32	8	2	2-2	1	1	83 m
KIT 750B	64	16	212	58	48	10	2	3-3	1	1	111 m
KIT 860B	64	16	212	58	48	10	2	3-3	1	1	119 m
KIT 960B	64	16	212	58	48	10	2	3-3	1	1	123 m
KIT 1060B	100	20	328	72	84	12	2	4-4	1	1	150 m

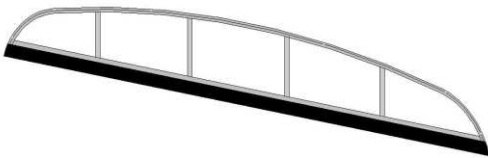
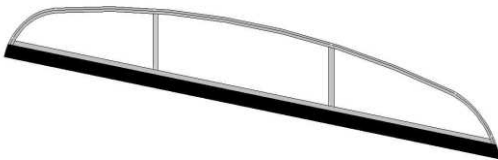

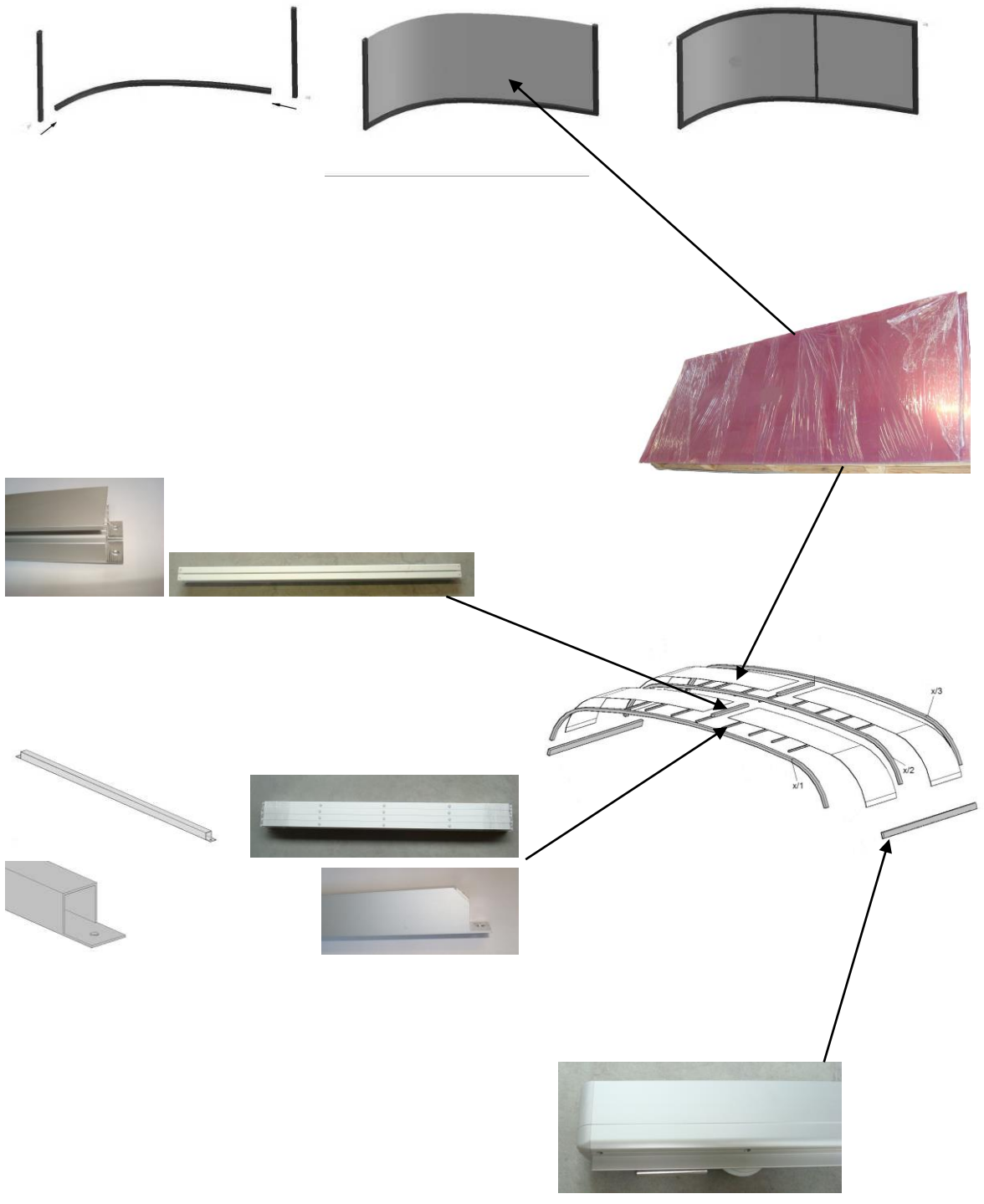

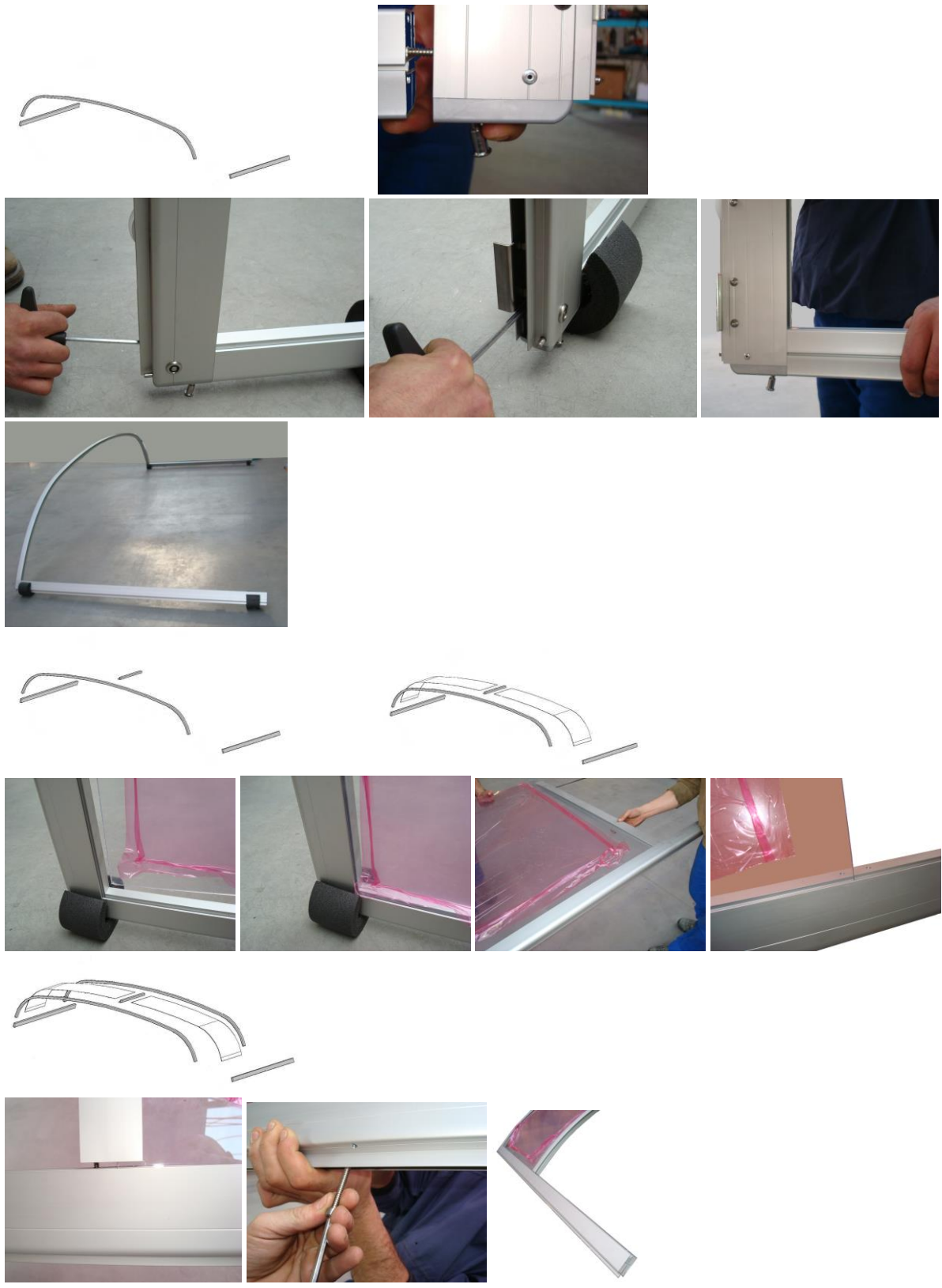

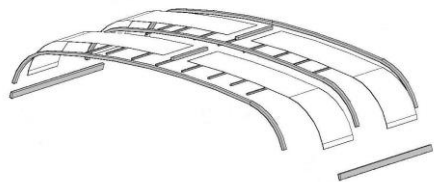
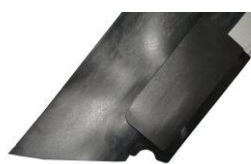
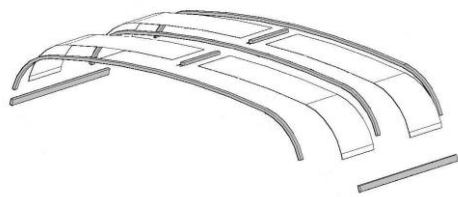
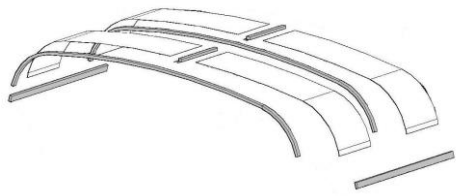
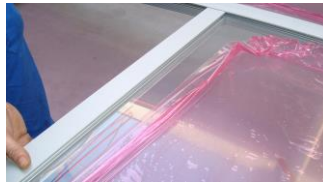
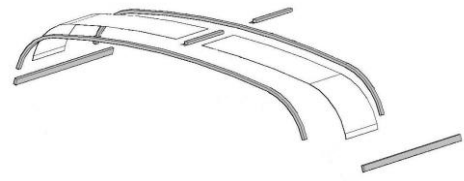

**Sliding door:**

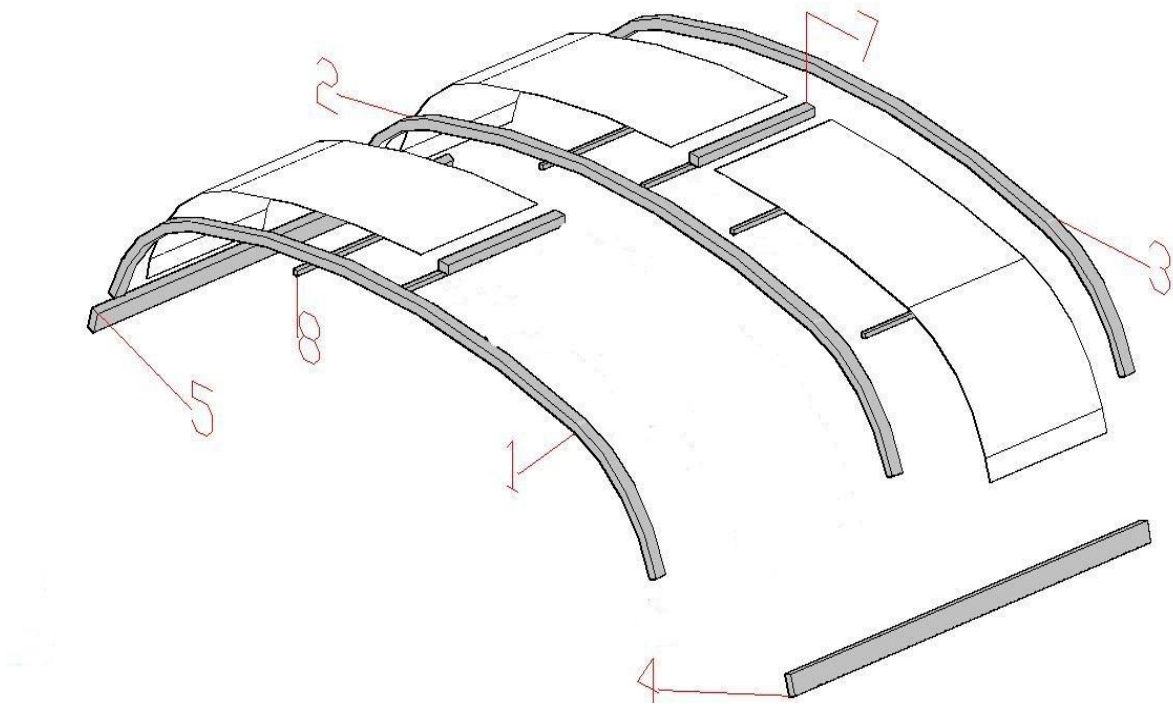
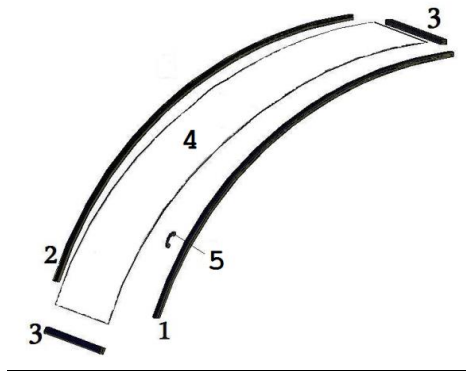

Number 4 and 5 wheelbar profiles are already assembled with the sliding door rail – so customer can choose the side of the sliding door

Number 7 : after to assembled completely the 1st section, sliding door rail needs to be assembled onto the top of the section.

Rubber use:

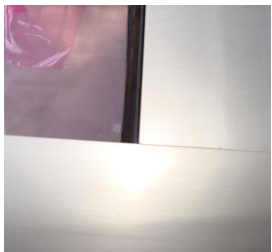



Das Glasbefestigungsgummi kann nur von einer Seite, von Aussen montiert werden.

Multi polycarbonate tightener rubber has to be used only outside of the sections.

