



T&A
MADE IN BELGIUM

EN



AUTOMATIC
SWIMMING POOL
COVERS

We've got you **covered!**

AUTOMATIC SWIMMING POOL COVERS



Since 1995 T&A has been producing high end quality pool covers and has grown out to be one of the leading manufacturers in Europe. Thanks to our constant investing in innovation and product development, we succeed in maintaining our market leader position. We manufacture swimming pool covers that meet and exceed your demands and all this with an unprecedented level of service and quality.

Quality

To ensure T&A quality, we test our raw materials and sub-assemblies before production and all finished goods will have passed by the experienced eye of our quality controllers before being installed with the customer.

Warranty

We grant a 3 year warranty on the finished product. A network of skilled professionals will take care of the planning, installation and maintenance of the cover. This will guarantee you a carefree enjoyment of your pool cover.

Reliability

Through years of experience, we have gained a tremendous expertise that we can draw from as far as looking for solutions to new challenges is concerned. This makes us unique in the market. On top of this, we have 15.000 m² of production and warehousing space with sufficient stock to keep our lead times short and reliable.

Service

We have been growing a lot over the years and in the year 2021 alone we will reach the amount of 8000 covers. However, customer friendliness, approachability and service remain top priorities for us. We invest a great deal in the training of our dealers and installers. We give them the support they need in 4 languages and through our web tool we hand them the possibility to configure their own cover and order it – or other parts – directly online 24/7.



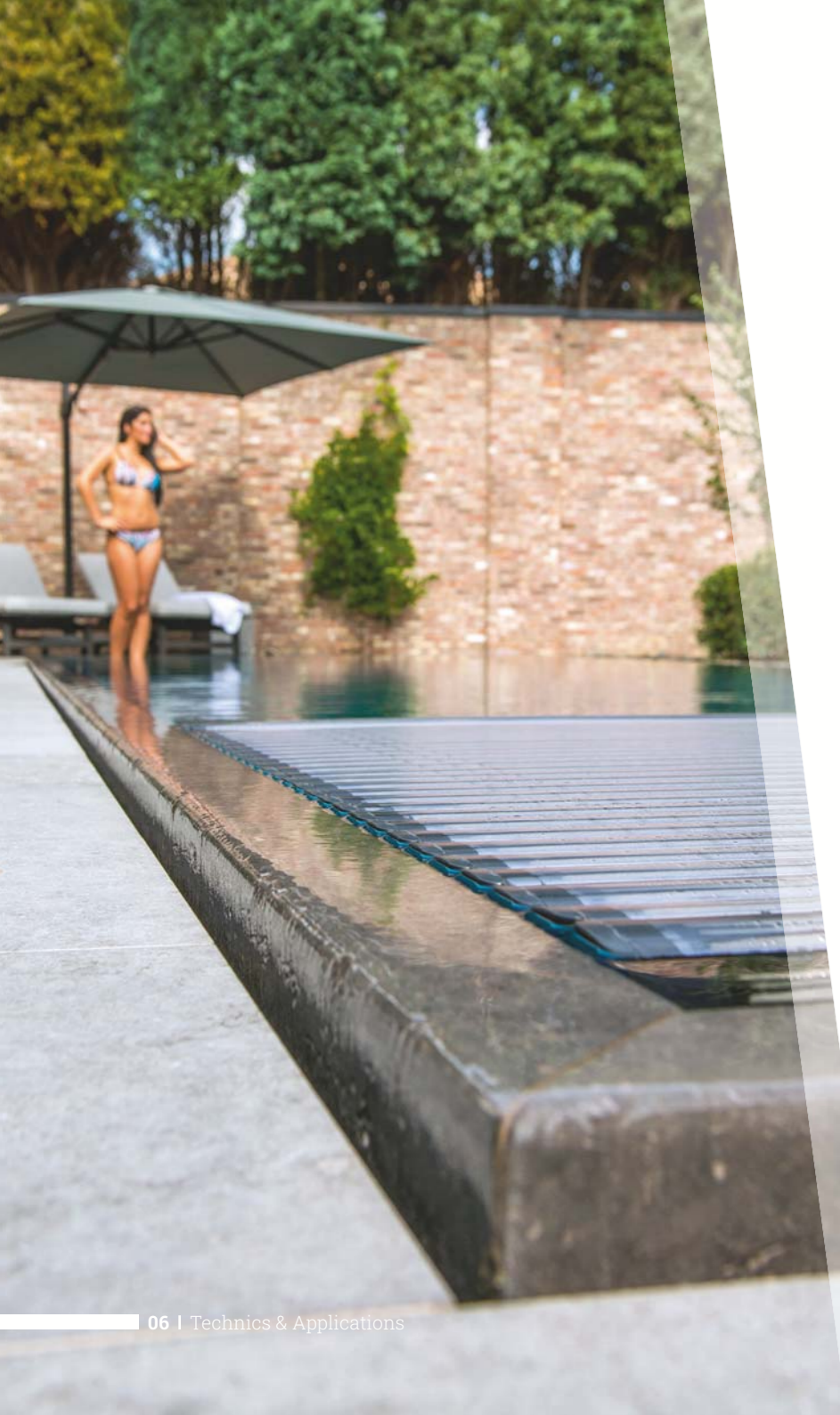

Safety

An AquaTop cover will contribute to the safety of your pool. Using optional locks (manual or automatic), this safety can even be enhanced.

Our products meet all European safety norms, including the very strict French.

Energy saving

The insulating effect of this cover will make a considerable difference as far as maintaining a constant temperature is concerned. Water evaporation can be countered and loss of warmth through conduction will be minimized thanks to the excellent insulating characteristics of our extruded PVC and PC slats. These factors combined will reduce the total heat loss by more than 80%.

Furthermore the temperature of your pool can be increased using solar slats which have a partially transparent upper layer and a black underlayer to retain the warmth of the available sunlight.

Ecological footprint

Solar slats reduce the ecological footprint of your swimming pool and will warm up your pool water by a few degrees resulting in savings on the energy cost. And this for as long as the sun's for free! At night they will also prevent your water from cooling down.

Comfort

Your comfort is important to us. Using a key switch, a remote control, a home automation system or our T&A CoverU app over WIFI, your AquaTop pool cover will work completely automatically.

Aesthetics

T&A offers a wide range of installation possibilities to match the aesthetic design of your pool and garden.





Universal control box



External motor



In-roller motor

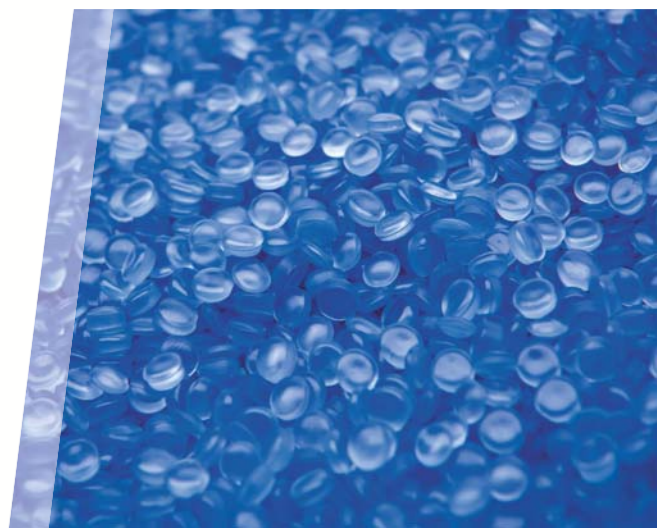

Technical

We offer a wide range of motors, from external electric over tubular motors to hydraulic drives for bigger pools. This means that our products are suited for private as well as bigger public pools.

For all stainless steel parts, we make use of the AISI 316L/316Ti stainless steel. To complete the technical picture we have designed a control box that can be integrated in an already set up home automation system or that can be connected to an intelligent pool control system.

Slats

The slats are the most important part of a pool cover. T&A has 2 kinds of slats in its range : the standard profile of 60 x 14 mm with 3 sealed air chambers and the slightly larger premium profile of 67,5 x 16,5 mm with 4 sealed air chambers. The first one is available in both PVC and PC, the latter only in PC. Our slats are safe, insulating , durable and made out of high end raw materials. They can be obtained in different colours to suit the look and feel of your pool, terrace or garden.

Tri- and Quadro-extrusion

Our slats are manufactured following the tri-and quadro- extrusion process. Using this method, all of our slats are covered with a UV protective layer making our polycarbonate slats much more UV resistant, resulting in an increase of life expectancy by half a life cycle. A polycarbonate slat is much more resistant to high and low temperatures than PVC slats. This makes polycarbonate slats suitable for use in every country regardless of the climate.

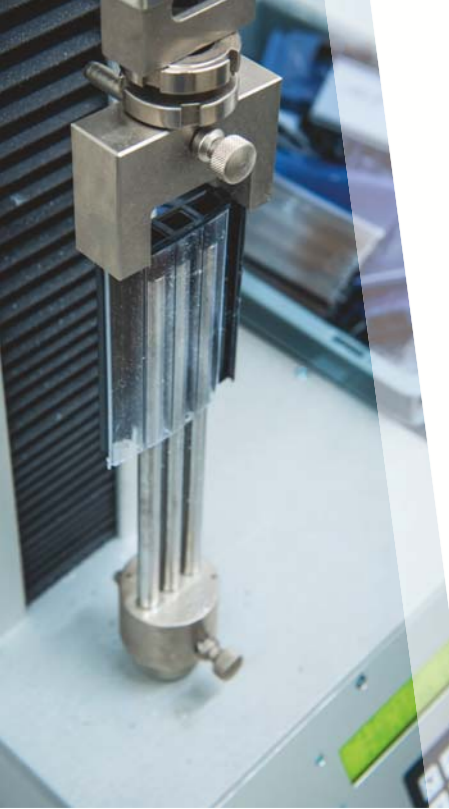

Impact resistance

Polycarbonate slats are much more resistant to impact than PVC slats. All of our slats are tested in Switzerland where one has to have all materials for outside use tested on impact resistance to hail. AquaTop PC slats meet the HW3 norm, which means as much as a 100% resistance to hail showers with up to 30 mm hail stones. Our larger Premium Clean Profile slats even meet the mechanical resistance of the HW4 norm, thus resistant to hail stones up to 40 mm diameter. Hence the conclusion that our slats are not only very impact resistant but also safe and durable.

Hollow or solid slats ?

Our slats are profiles with sealed air chambers. This results in a higher buoyancy compared to solid profiles. As to the insulating properties they can both be put on the same level. When opting for a hollow slat you can choose for a solar version which is not an option for solid slats. Our brand new polycarbonate profiles offer high impact resistance and consequently also hail resistance, combined with solar, anti-algae and anti-condensation qualities. When you choose an AquaTop cover, you are buying the best technology on the market! These slats are available in the "Black" and "Titanium" version and offer your pool a stylish and aesthetic character.

Sealing

All of our slats are sealed with caps that are either glued or ultrasonically welded. In the case of welded caps, we have a range of click parts in several dimensions to compensate for possible differences in the width of the pool. In addition to optimal quality, reliability and durability, slats with welded end caps also ensure a neat finish and a modern look.

PVC 60



White



Beige



Blue

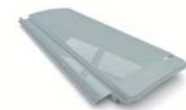

Grey

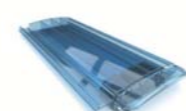

Transparent

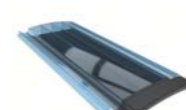

Solar

PC 60



Quadro Black AA



Quadro Titanium AA



Transparent

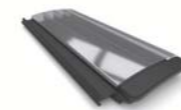

Alu Look

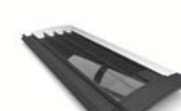

Solar

PC 67,5



Alu Look AA

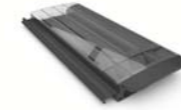

Solar AA

Excellence through Innovation Quadro profile

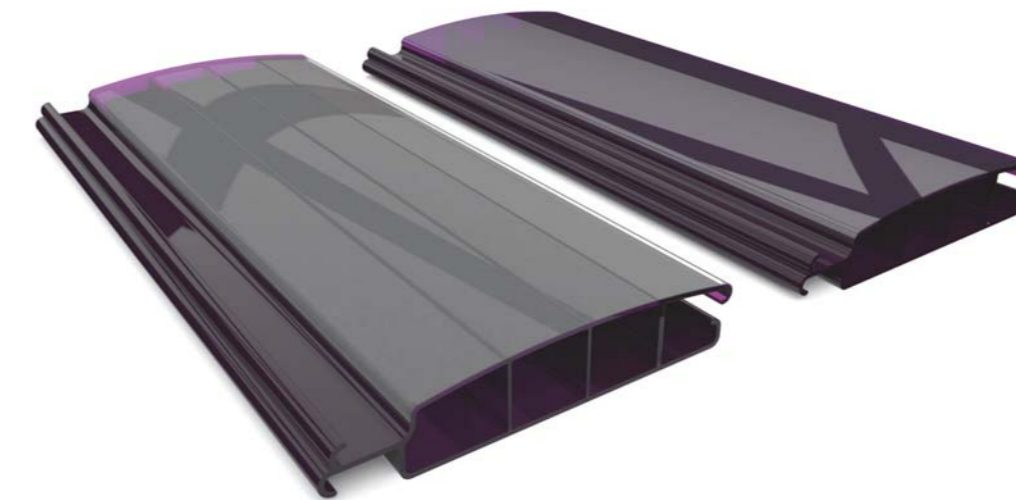

Advantages of our newest polycarbonate slats in "Black" or "Titanium" version

- > Minimal growth of algae because of the blocking of sunlight in the hinge point thanks to the patented technology of Quadro-Extrusion
- > Lower visibility of condensation through the use of a selective colour pigment
- > For new as well as replacement covers

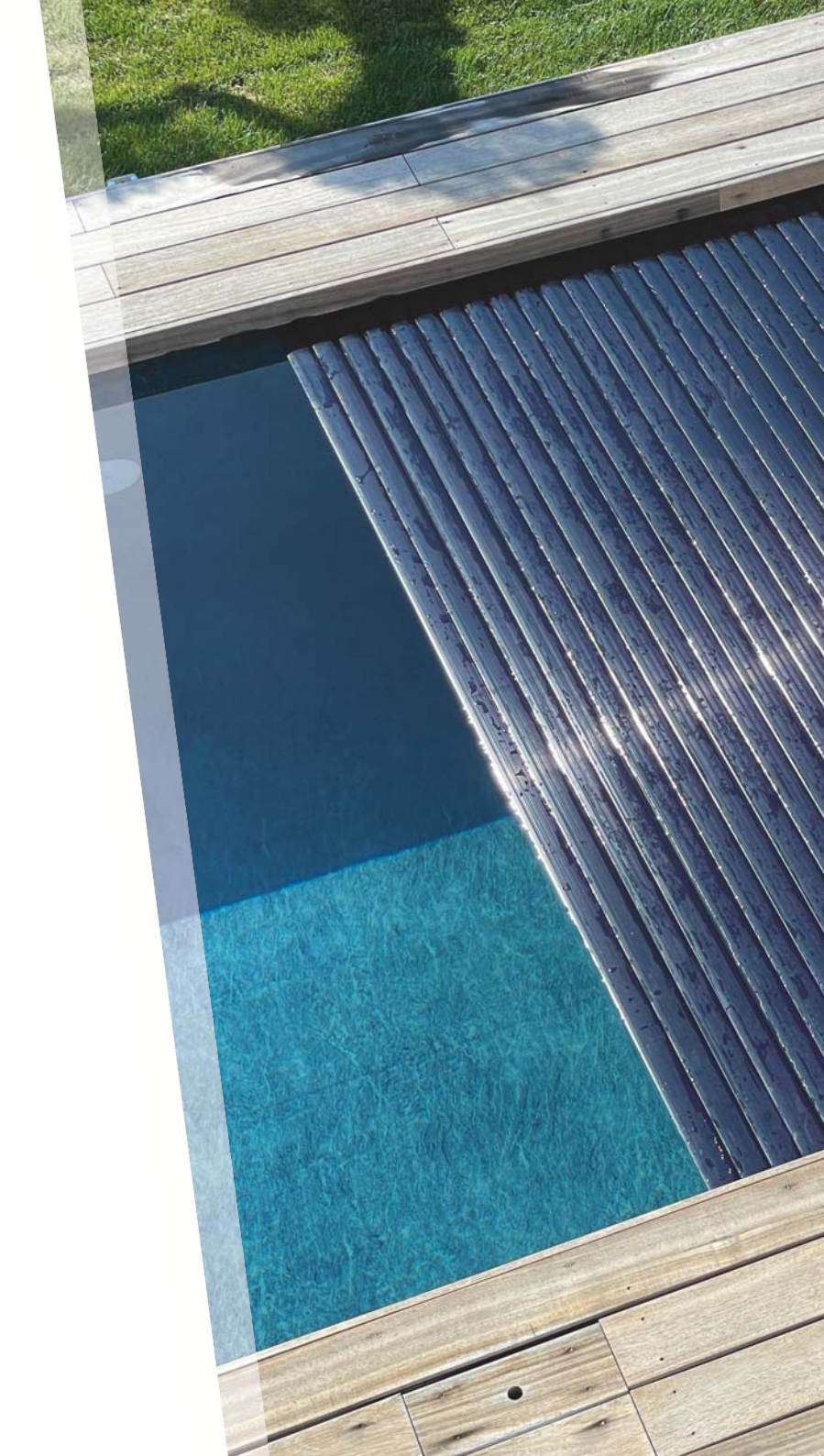



Innovations

Quadro-Extrusion

Our latest polycarbonate slats are manufactured using quadro-extrusion technology. This technology is unique in the world of swimming pool covers and enables us to produce a perfect solar slat that is extremely impact-resistant and durable and also combines solar, anti-algae and anti-condensation qualities.

Black & Titanium Edition

Using a selective colour pigment, we do not only manufacture high quality and durable slats, we also emphasize the aesthetic character of your pool. With the “Black” edition, you are opting for a stylish and exclusive rollo-cover. Slats in the “Titanium” version will make your cover look very modern and eye-catching. Both editions have efficient solar qualities reducing the growth of algae in the hinge and will minimize the visibility of condensation.

Coverwash

The cover control box will initiate a system with a booster pump and special nozzles. Every time the cover opens or closes, this system will clean the slats. The cover will remain clean and this will reduce the amount of scale and other dirt. Intensive cleaning of your pool cover can therefore be removed from your to-do list. What a godsend !

TopLock

Safety first! An Aquatop cover can be equipped with a TopLock system. This will secure itself automatically when closing the cover. TopLock is a very reliable system. The cover control box will switch on a compressor that will unlock the safety system. If the pressure drops, the lock will close itself using a spring.





Top Mount covers

EcoTop

Our basic model. An insulating slatted cover at an interesting price, easy to install and operate thanks to an integrated key switch.



EcoTop solar

You're already the proud owner of a pool but you want a cover that can be installed rapidly and easily? Here's EcoTop Solar for you. Easy to install and with the built in solar panel and battery, you can have it work standalone.

TopMoov solar

Is a movable variant of the EcoTop. By putting the cover on a rail it can be moved backwards when using the swimming pool. The high end finishing will turn it into a comfortable bench to relax and enjoy the sun or keep an eye on the children. You want to close the pool? Just slide the mechanism towards the pool and roll off the cover.





Top Comfort

A simple slatted cover placed at the end of the pool. The supports in stainless steel with wooden finishing give it a very modern look.

Top Premium

A wooden bench hides the cover when the pool is in use. It can be used to sit and relax on.

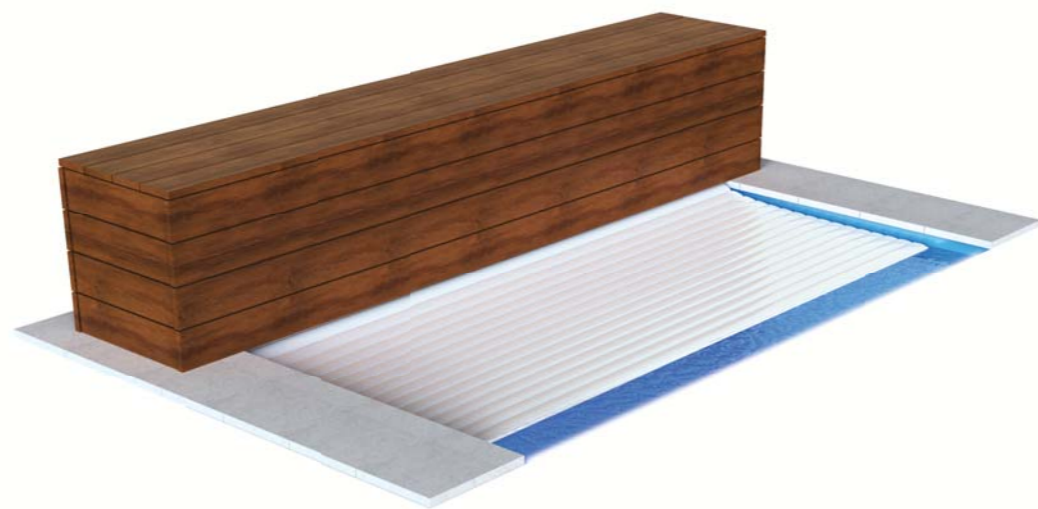



Integrated covers

Classic Line

Choosing for an integrated cover this is the most classic version of all. Aesthetically integrated in a separated rollo cover pit. The type of finishing is up to you : wood or stone. For pools with a high water level T&A has developed special brackets and guide wheels.

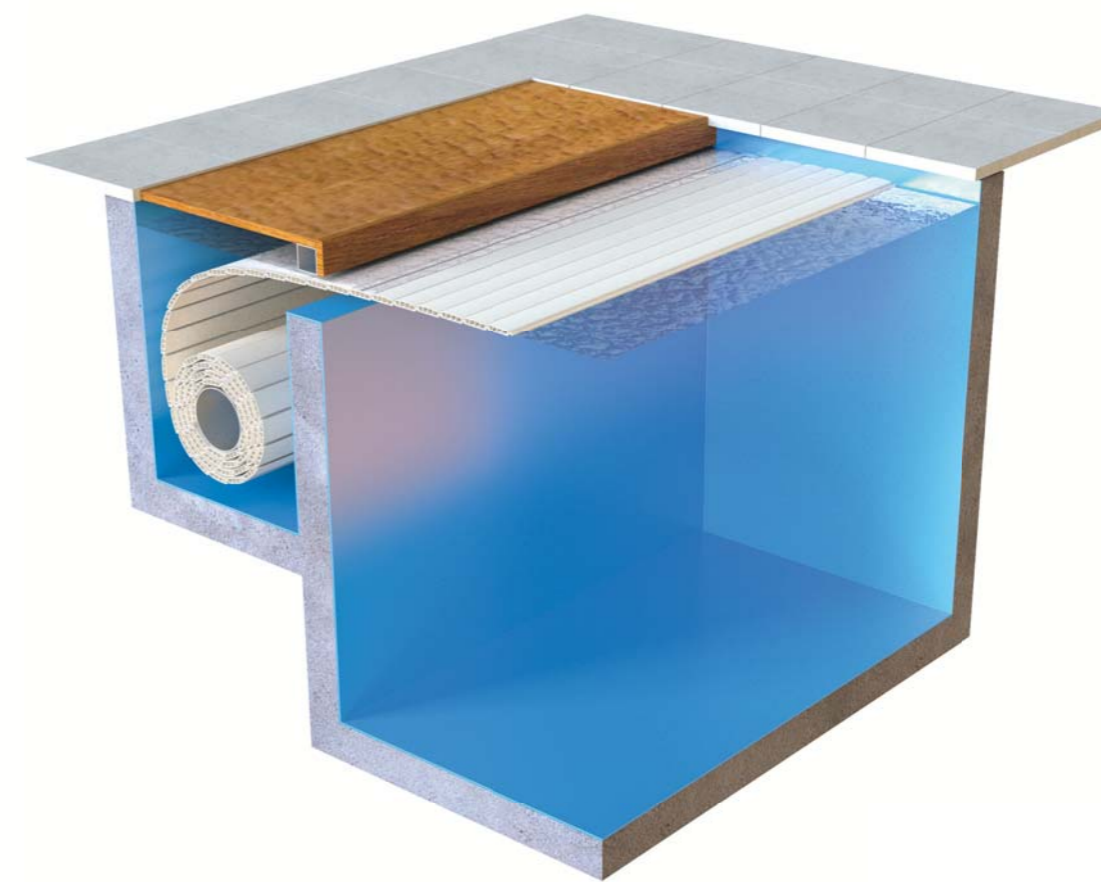

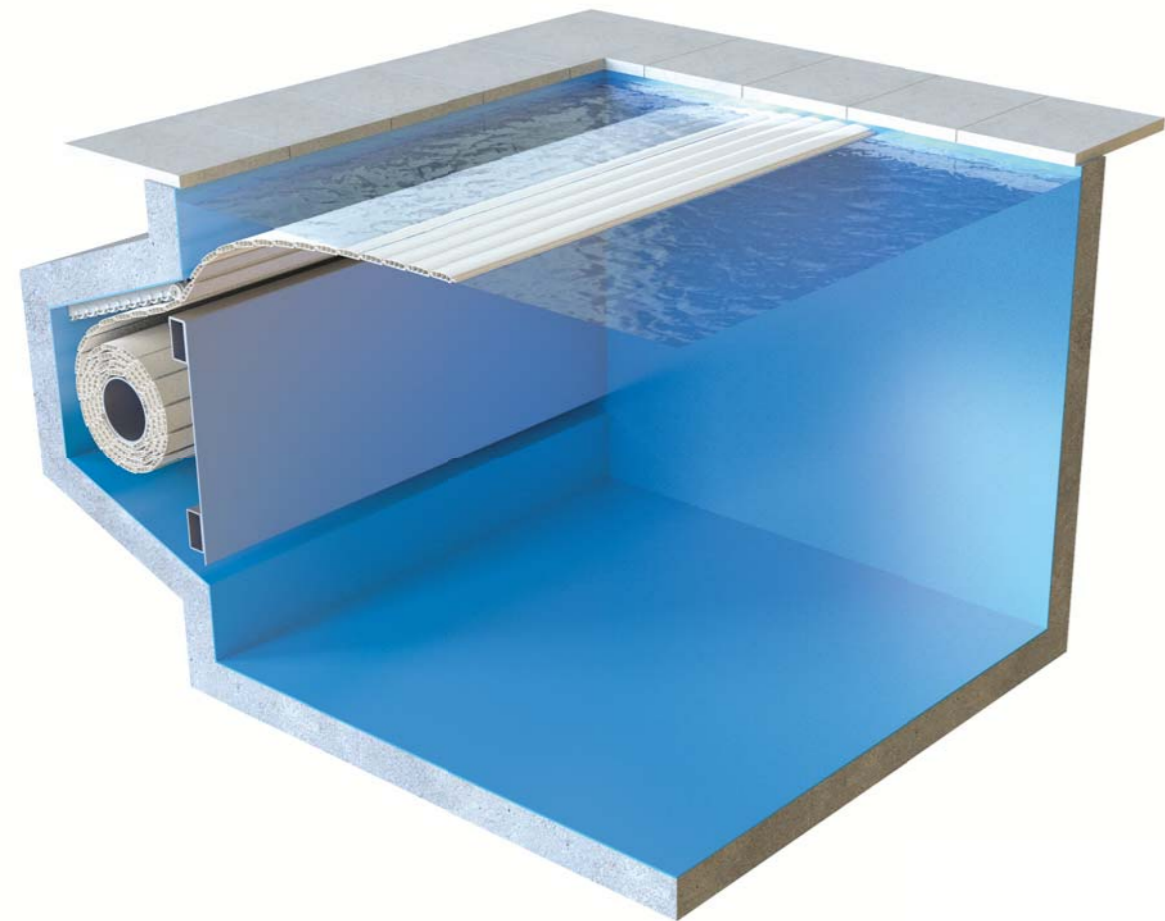

Elegant Line

In case you want to have your cover integrated in a discrete way this will be your thing. The pool cover will be built in under water level in the wall at the back of your pool. A panel will close the cover niche that is constructed slightly oblique to prevent stagnant water. There are several possibilities to finish the screening plate using liner, mosaic, natural stone or vinylester in a RAL colour of your choice.



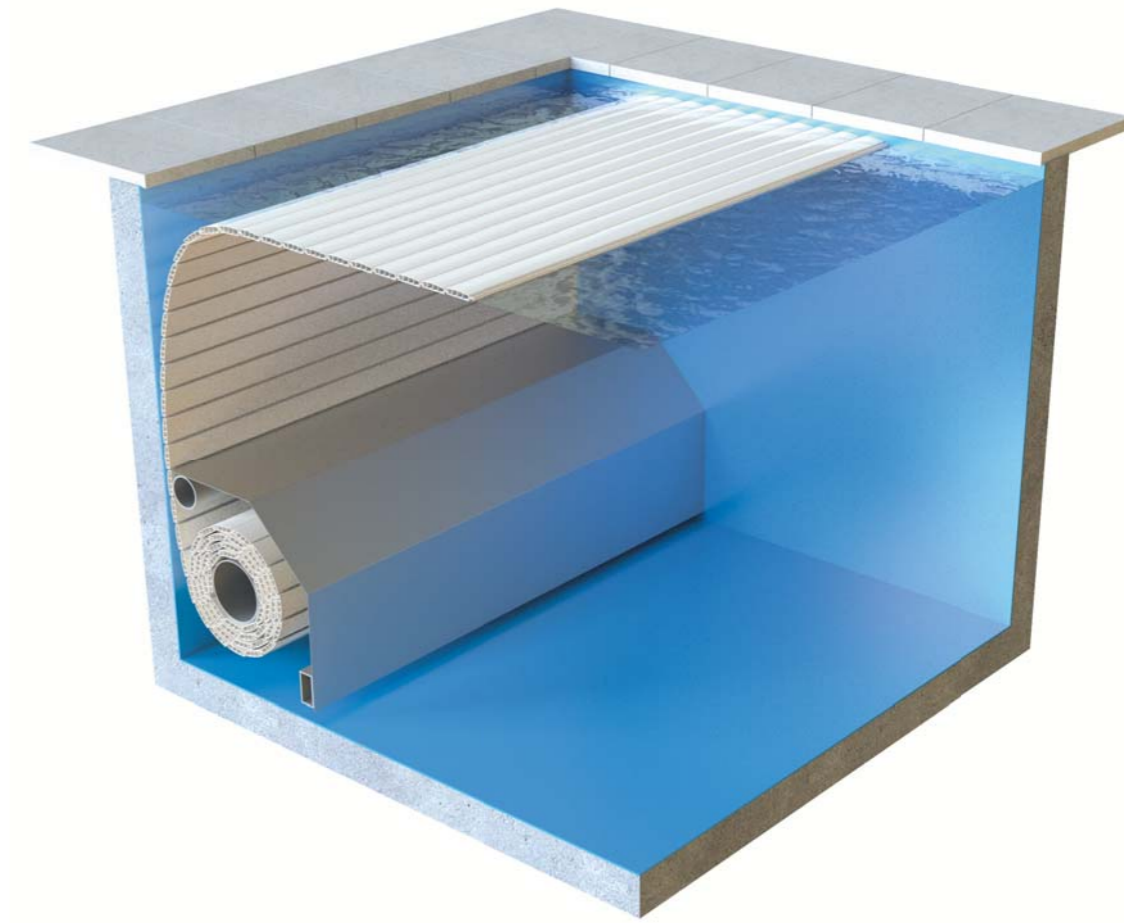

Reno Line

The cover is hidden under a bench on the bottom of the pool. This will give you the advantage of being able to use the full length of your pool. An ideal solution when renovating. The housing can be finished with liner, mosaic or tiles or T&A can supply it in vinyl ester in the RAL colour of your choice.

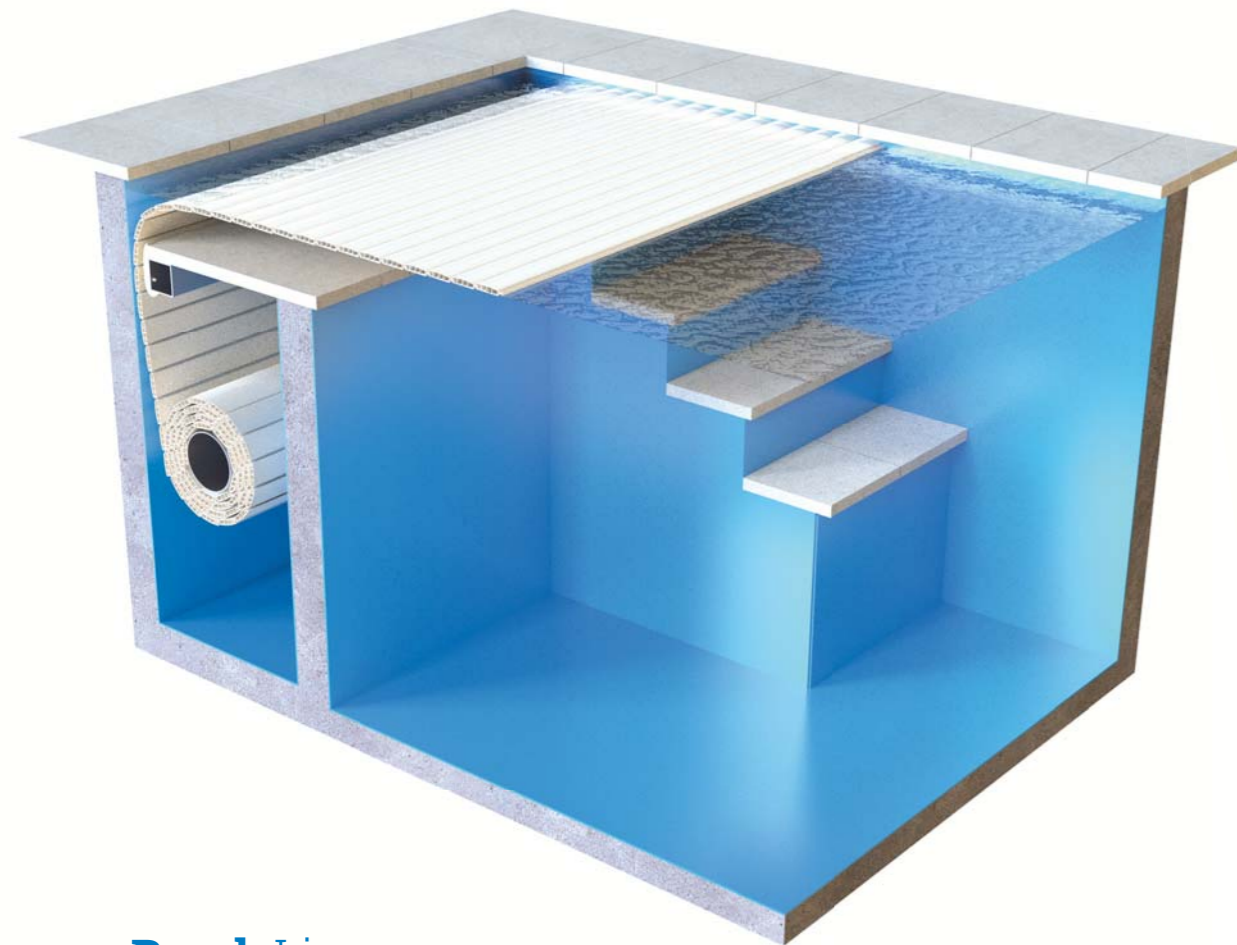

Beach Line

More and more people opt for the possibility to put the cover under the first step of their staircase thus creating a shallow space that can be used as a relaxing zone.



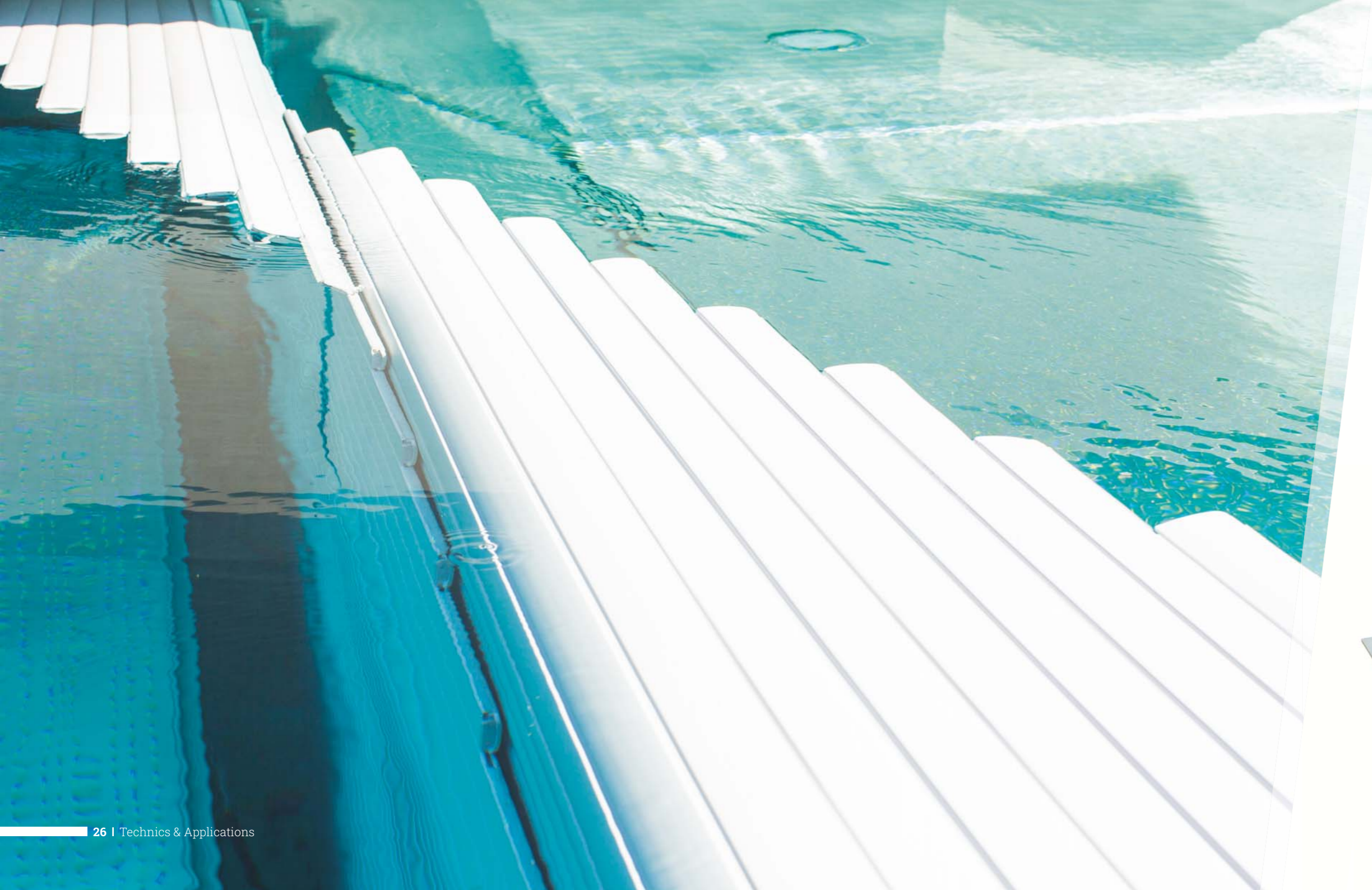

Exclusive Line

FIXED PANEL

The mechanism is put away in the bottom of the pool. Using a cover panel that is slightly smaller than the rollo pit, this will create a way leave through which the cover can be rolled.

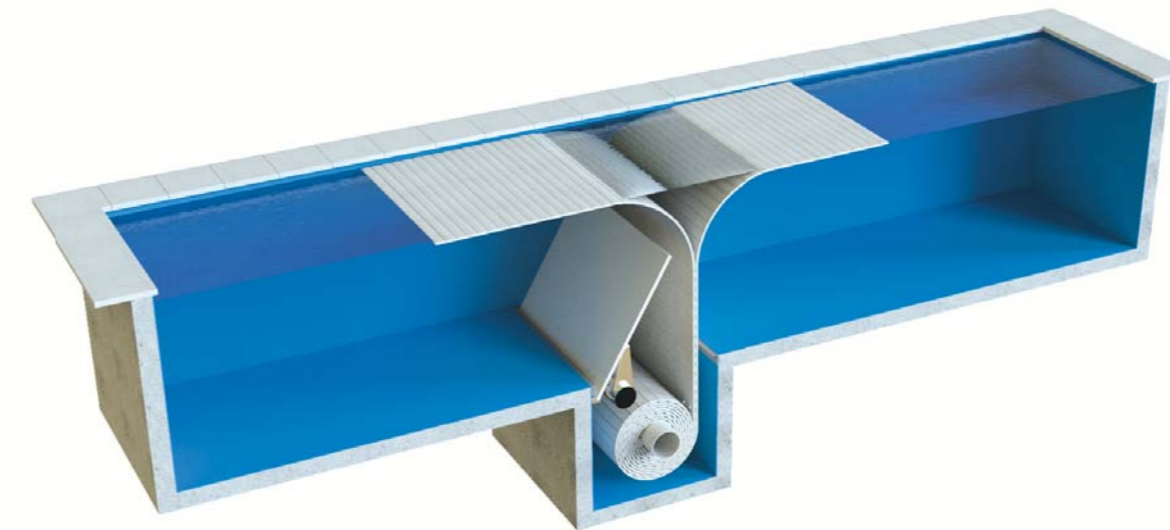
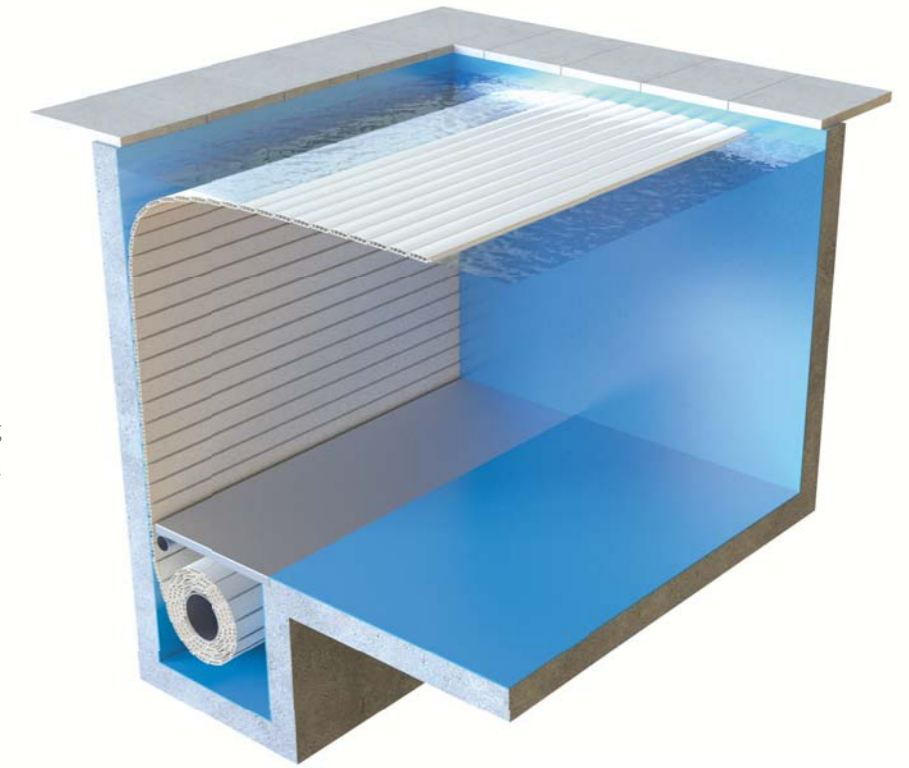

AUTOMATIC PANEL

Using an automatic lid that will close the cover pit completely, the slatted cover will be stashed away invisibly. A so called master-slave system will be installed that will have a first motor opening the lid and a second one initiating the cover.



A swimming pool cover consisting of fiberglass reinforced PVC fabric sliding over the water in aluminum tracks. Your pool will be opened/closed in no time. This kind of cover can be installed on both new and existing pools and is a top product because of its safety and cleanliness characteristics.

Safety

AquaGuard is one of the safest covers -if not the safest- on the market. The buoyancy of the water combined with the strength of the fabric will make it possible for children, adults and pets to walk over the pool. An evacuation pump delivered with the AquaGuard will drain the excess rain water from the fabric. This cover will secure itself, no need for extra manipulation. Complies with the French NF P 90-308 norm.

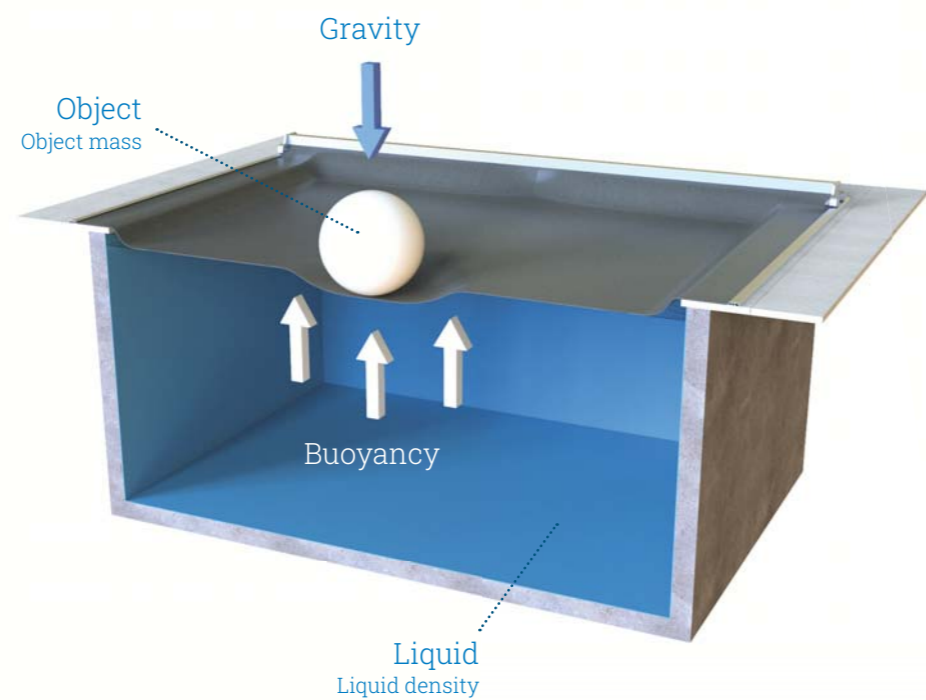



Cleanliness

An AquaGuard will shut itself hermetically in a few seconds leaving no possibility for dirt such as leaves or other filth to get to the pool. All the dirt will be gathered on the fabric and can be swept off very easily. Because of its opaque finishing not only dirt but also the light will be blocked giving no chance for algae to grow underneath. Consequently you will need fewer chemicals and cleaning products.

Energy

The fabric will minimize the loss of energy through evaporation. During day time, the pool will warm itself slightly through the heat that is generated by the sunlight and passed on through the fabric. However, this heat generation cannot be compared to that of solar slats.

Materials

An AquaGuard is made out of a high end reinforced PVC fabric of 580g/m² with a UV resistant layer. It is available in 7 different colors to match the design of your pool and terrace.

The aluminum tracks are anodized with 25 micron, which will make them corrosion resistant. A hydraulic pump group will activate the motor. Reliable, durable and safe.

Operating system

The fabric is guided through the aluminum tracks by means of polyester ropes with a Kevlar® core. When opening the pool, the cover will be rolled onto an aluminum tube at the end of the pool. The cover is operated through a key switch or touchscreen that is installed in a location where you have a clear view on the pool. In addition, the control board has outputs for controlling other devices depending on the position of the cover. For example, you can slow down your filter pump when the cover is closed. Good for your wallet and the quality of your pool water thanks to a more effective filtration.



Rail systems

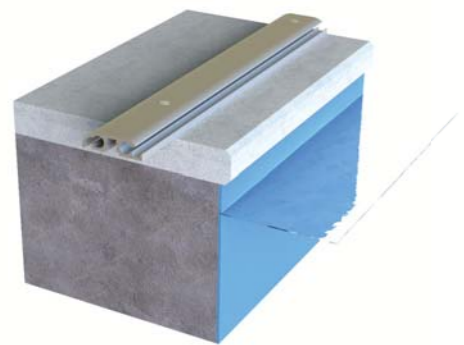

Top tracks

The tracks are placed on the coping stones of the swimming pool. Their rounded shape will prevent you from hurting yourself.

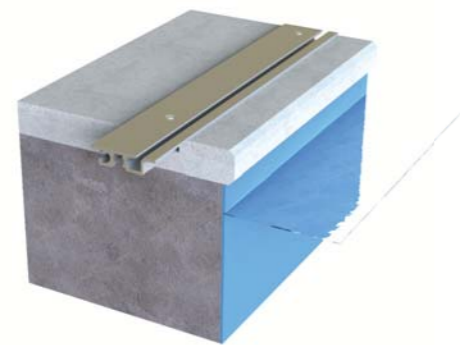

Flush tracks

The tracks are placed at the same level as the terrace or coping stones.

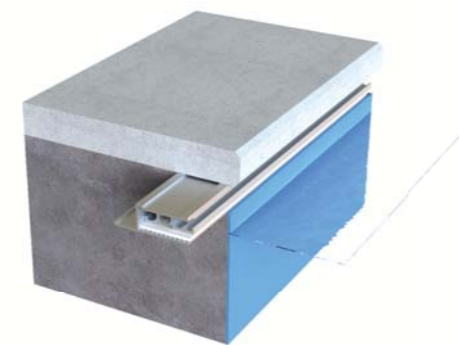

Under tracks

The tracks are placed under the coping stones, offering a discrete and aesthetical integration of your cover.

Fabric colors



Light blue

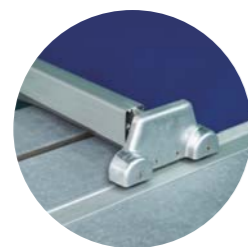

Dark blue

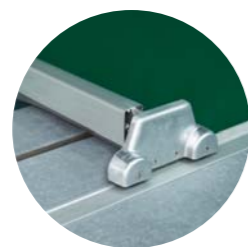

Olive green

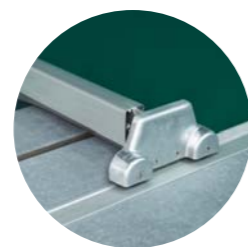

Green



Beige

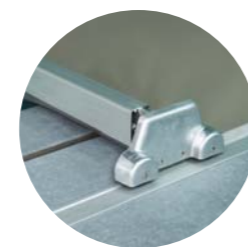

Light grey

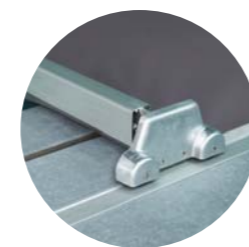

Dark grey



Skimmer pool with tracks under the coping stone. The fabric is attached to a beam in anodized aluminum.



SPAFLEX AUTOMATIC SPA & SWIMSPA COVER

A SpaFlex is an automatic cover for a swimming or regular spa. This cover is made out of an insulating PE foam sandwiched between 2 layers of PVC reinforced fabric.

This will keep your water at an enjoyable temperature. The SpaFlex will also prevent the water from evaporating and will keep it clean.

A hydraulic motor will activate the cover. The cover can be integrated in a pit or bench finished with the material of your choice. An evacuation pump will drain the excess rain water from the fabric if needed.



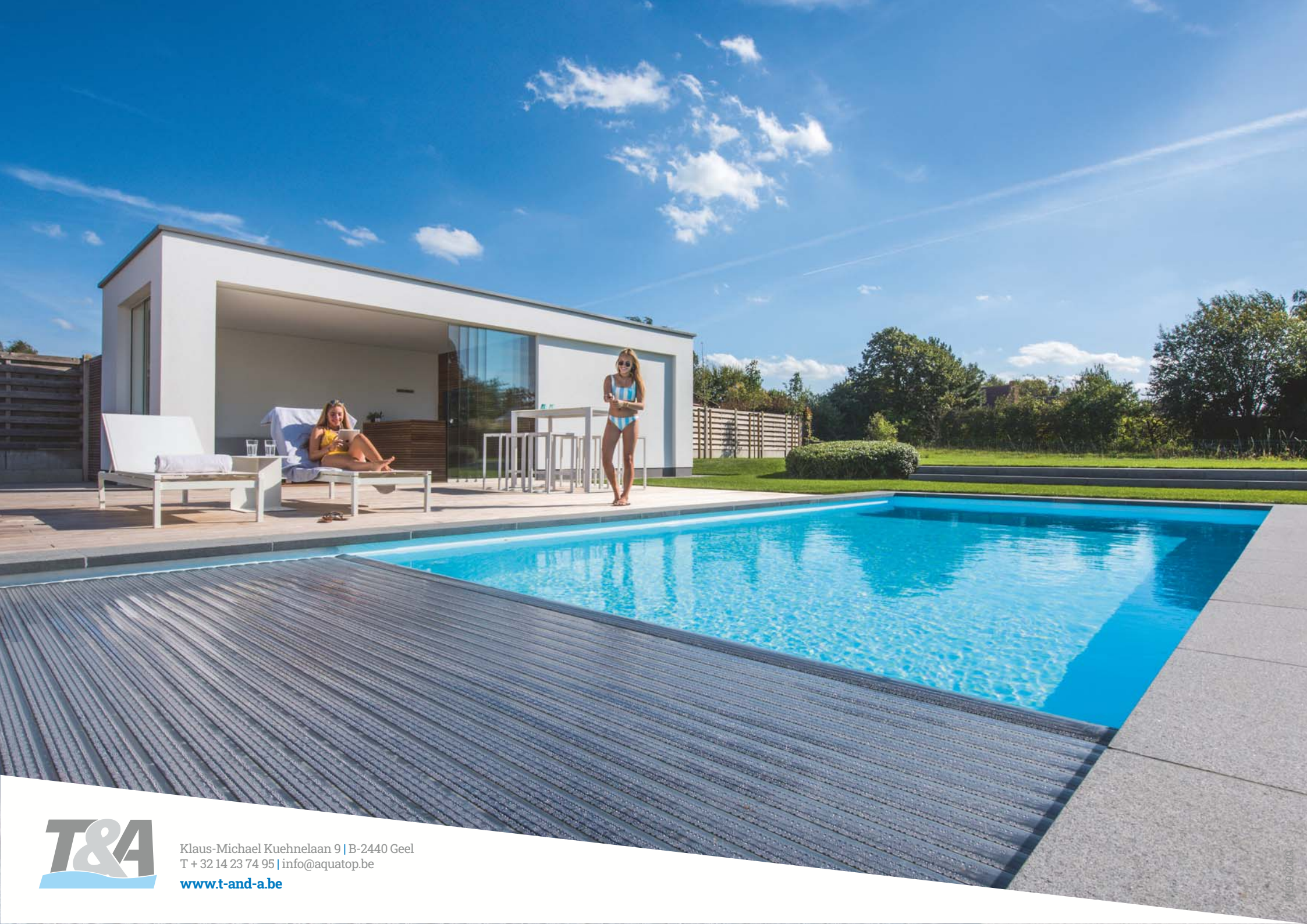

Klaus-Michael Kuehnelaan 9 | B-2440 Geel
T + 32 14 23 74 95 | info@aquatop.be
www.t-and-a.be